

Varenummer: 20262012
Beskrivelse: E+G
Positioneringsbolt GN 817-4-6-G

Mål

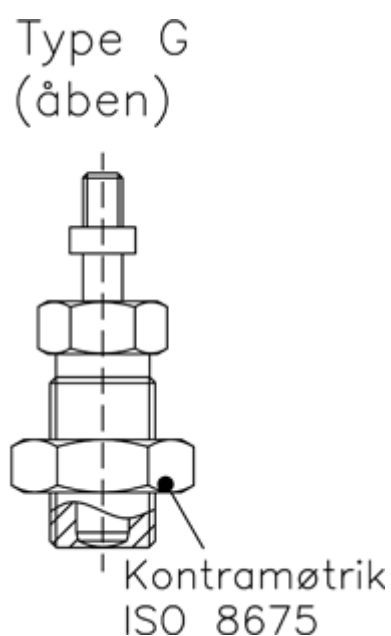
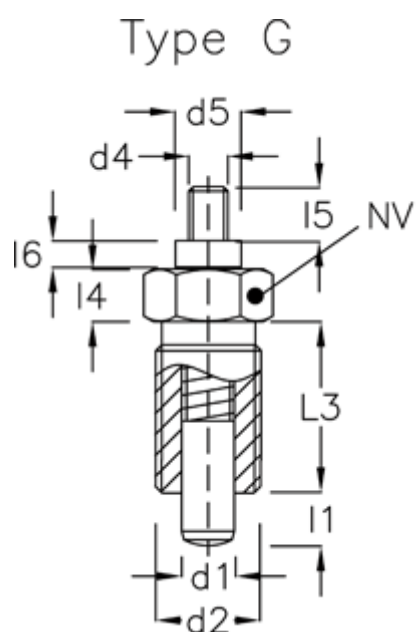

d1	= 4	l4	= 5
d2	= M8x1	l5	= 4.5
d4	= M3	l6	= 2.5
d5	= 7	NV	= 10
Fjedertryk N bund	= 12.5		
Fjedertryk N top	= 4.0		
l1	= 6		
l3	= 16		